



Introduction

Dear Customer,

Congratulations on your purchase. After years of engineering expertise and critical testing procedures, we have created a wide range of products that reproduce music with all the clarity and richness you deserve. Please read your warranty and retain your receipt and original carton for possible future use. After reading your manual, if you still have questions regarding this product, we recommend that you email us at support@retrosoundusa.com or call us at 909-364-1372.

BEFORE YOU INSTALL:

CAUTION: If you feel unsure about installing this system yourself, have it installed by a qualified professional installer.

Before beginning any installation, follow these simple rules:

1. Be sure to carefully read and understand the instructions before attempting to install the RetroPods.
2. For safety, disconnect the negative lead from the battery prior to beginning the installation.
3. For easier assembly, we suggest you run all wires prior to mounting your unit in place.
4. Use high quality connectors for a reliable installation and to minimize signal or power loss.
5. Think before you drill! Be careful not to cut or drill into gas tanks, fuel lines, brake or hydraulic lines, vacuum lines or electrical wiring when working on any vehicle.
6. Never run wires underneath the vehicle. Running the wires inside the vehicle provides the best protection.
7. Avoid running wires over or through sharp edges. Use rubber or plastic grommets to protect any wires routed through metal, especially the firewall.

INSTALLATION CONSIDERATIONS

This product requires the use of specialized tools to cut, sand, and shape plastic to help make sure the final result is as professional as possible. This install guide assumes that you have access to and are proficient with these tools (see below).

RECOMMENDED ITEMS NEEDED FOR INSTALLATION:

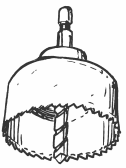

Hole Saw



File



Air Saw (used with compressor)



Variable Speed Rotary Tool

Where to mount your RetroPods

The RetroPods are designed to allow you to mount speakers onto most surfaces in your vehicle where speakers normally cannot be installed. Below are some examples of common places to mount the 3 different versions of the RetroPods:

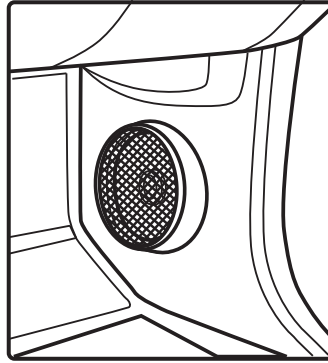

Kick Panel
(shown with RPOD6)

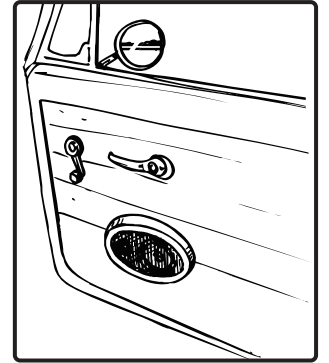

Door Panel
(shown with RPOD9)

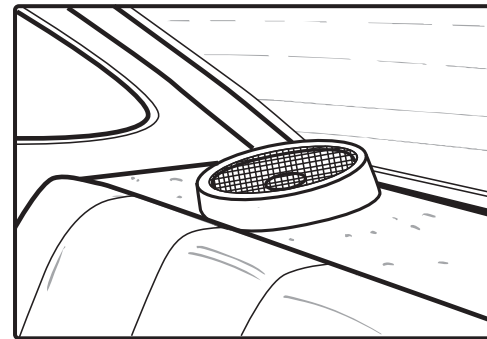

Rear Deck Panel
(shown with RPOD6, RPOD4 & 9 may also work)

NOTE: Please note that the above illustrations are examples only. Your vehicle may have different mounting requirements.

Note: The information enclosed in this installation guide is to be used as merely an outline to assist you during the process of installation. This guide does not cover every installation possibility, vehicle or every aspect of the installation process.
Retro Manufacturing, LLC or its subsidiaries, assume no responsibility for a proper or improper installation. We have made efforts in good faith to make this guide as informative as possible, and therefore it may be updated from time to time. Please check our website for the latest update: retrosoundusa.com

Copyright 2014 © Retro Manufacturing, LLC
No text, illustrations or format of this manual in printed or electronic form may be copied without written permission from Retro Manufacturing, LLC. All rights reserved.

VERSION 1.0

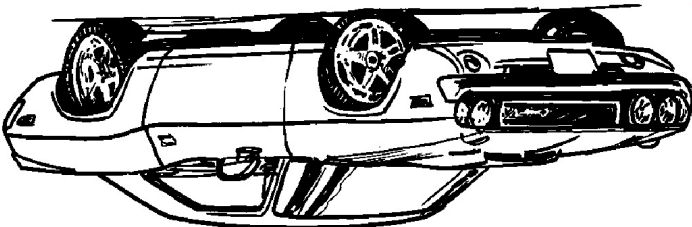
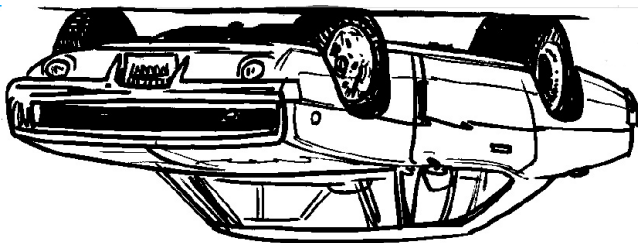
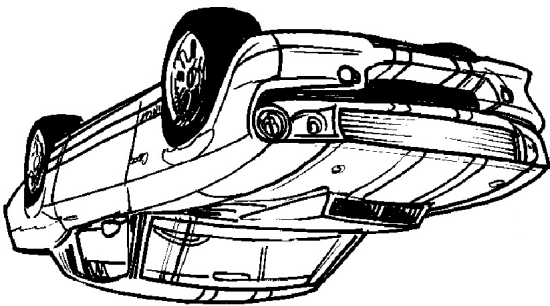

Installation Guide



Note: RetroPod products are designed to be modified. Once modified, they are not covered by this warranty. Warranty does not cover damaged or lost grilles or other included accessories. If your unmodified product does not work properly due to defects in materials and workmanship, Retro Manufacturing, LLC (collectively referred to as "the warrantor") will, for the length of the period indicated in the chart below, which starts with the date of original purchase ("warranty period"), at its option either (a) repair your product with new or refurbished parts, or (b) replace it with a new or refurbished product. The decision to repair or replace will be made by the warrantor. During the "Labor" warranty period, there will be no charge for labor. During the "Parts" warranty period, there will be no charge for parts. You must mail in your product prepaid during the warranty period. If batteries are included, they are not warranted. This warranty only applies to products purchased and serviced in the United States, Alaska, Hawaii or Puerto Rico. This warranty is extended only to the original purchaser of a new product which was not sold "as is". A purchase receipt or other proof of the original purchase date is required for warranty service.
To handle a warranty issue, contact us at support@retrosoundusa.com or 909-364-1372 and get a Return Authorization number. All returns and warranty issues must receive a Return Authorization (RA) number. Any product received without a RA number will be refused.
Retro Manufacturing, LLC
Phone: 909-364-1372
Fax: 909-364-8670

Limited Warranty - Parts: 1 Year Labor: 1 Year

Limited Warranty

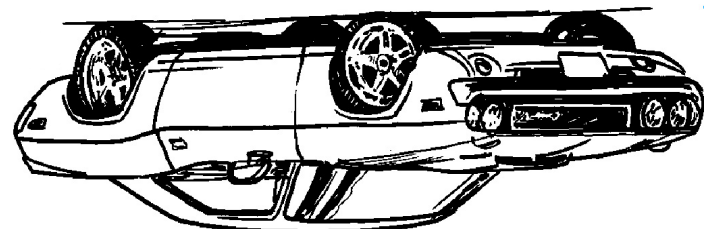

Installation Guide



About RetroPods

1

All RetroPods have speaker sizing already etched into the top panel to help you cut them. Below are illustrations with the recommended speaker sizes for each Pod.

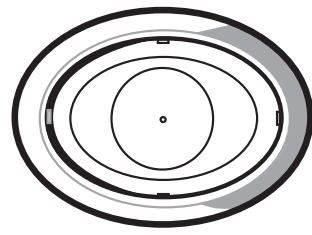

RPOD4
(Pre-cut guides for:
4", and 4x6" speakers)

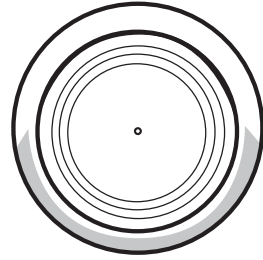

RPOD6
(Pre-cut guides for:
6.5", 5.25" and 4" speakers)

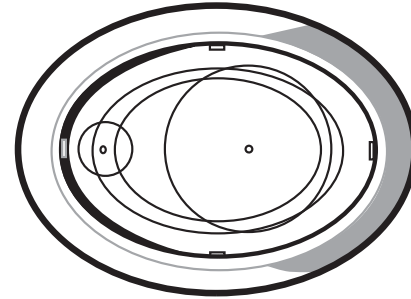

RPOD9
(Pre-cut guides for:
6.5" Component kit w/ Tweeter, 6x9" and 4x8" speaker)

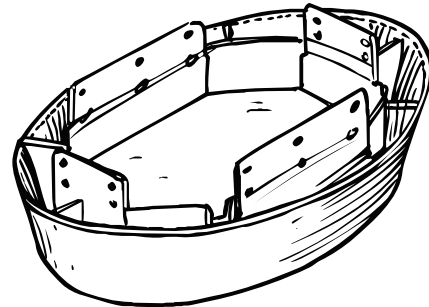

Bottom view of
RetroPod

Mounting the RetroPods to the Install Location

3

Before mounting the RetroPod to the desired location, make sure the area behind the panel or deck that you will mount the RetroPod onto does not have any electrical, fuel, brake or other critical areas that may be damaged when installing the unit.

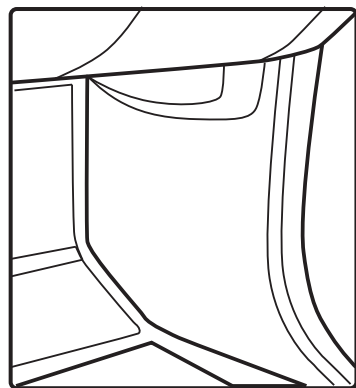

Mounting example: Kick Panel

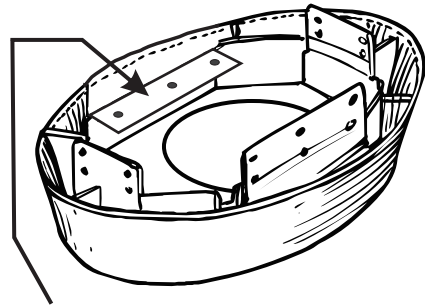

Bend all 4 mounting tabs to
prepare the RetroPod for mounting.

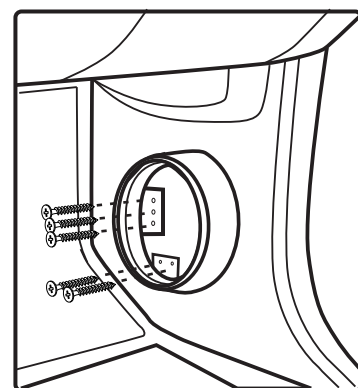

Screw the RetroPod onto
the desired location.
(NOTE: if mounting to a non-flat
surface, some additional modification
to the RetroPod may be necessary).

Modifying the RetroPods

2

Once you've chosen the optimum location for installing your RetroPods, as well as your speakers, now it's time to modify the RetroPods using a combination of specialized tools outlined earlier in this manual

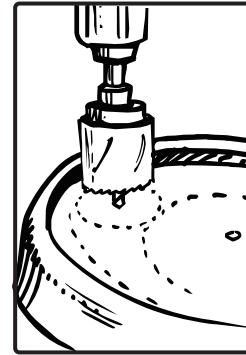

After choosing which speaker size channel to modify, use a hole saw or a drill to start cutting out the hole to allow the air saw blade enough room to cut out the remainder.

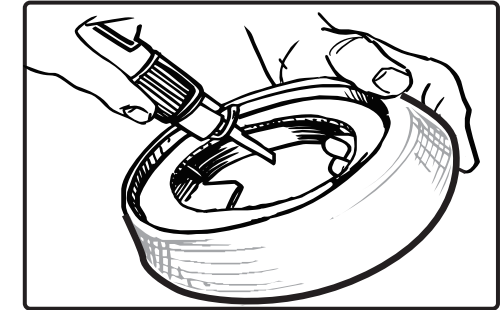

Using the air saw tool, carefully cut material close to the cut out channel. Do not cut along the channel line with the saw. It is important to allow for some extra material to ensure a tight fit.

Now use a file to trim off and smooth out the excess plastic. It's important to test fit the speaker in the hole you've cut at several points at this stage to make sure that you get the best fit possible.

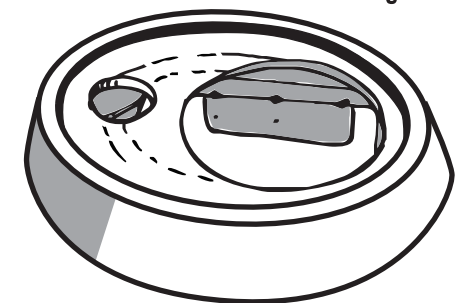
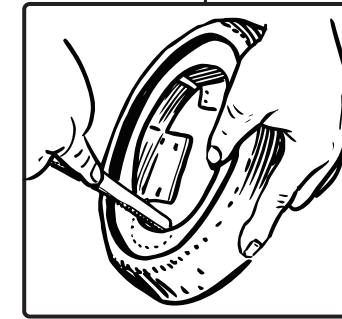

After modification and test fitting is complete you're ready to mount the RetroPod to the location and mount the speaker.

Mounting the Speakers & Grilles

4

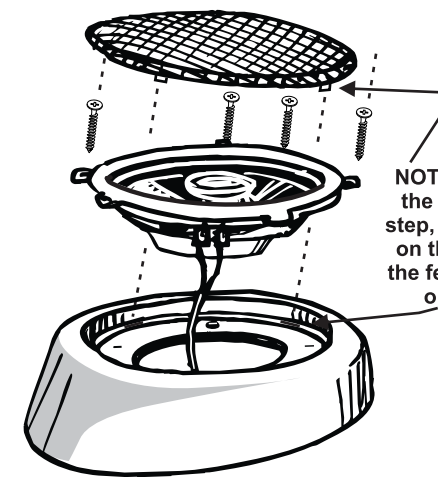

Once the RetroPod is mounted, drill needed holes for wiring. Connect wiring and mount the speaker using screws, then mount the grille.

Detailed view showing speaker mounted in RetroPod and mounted to desired location.

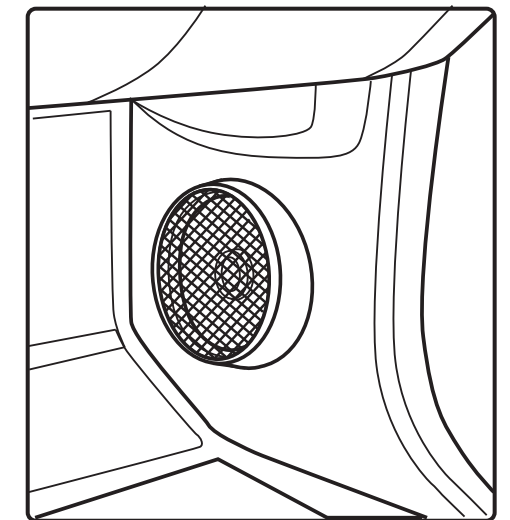

Install complete